

POWERHEAT 



POWERHEAT

POWERHEAT is the new style (engine) pre-heater. The compact design, in combination with the chosen materials, integrated pump, adjustable thermostat and all required control and safety features, makes it an exceptional high quality heater.

The heat exchanger is based on a die-cast tubular component in aluminum with a large heating surface. The heating element is embedded in aluminum during the die-casting process so therefore completely corrosion proof and not in direct contact with the coolant or liquids.

This means a more effective heating and no negative side effects for the coolant or liquids. In addition the Aluminum AS13 is finished with a Teflon coating.

POWERHEAT model	PH3690-4500	PH3690-6000	PH3690-7500	PH3690-9000
Voltage range	690 V / 50-60 Hz / 3 Ph	690 V / 50-60 Hz / 3 Ph	690 V / 50-60 Hz / 3 Ph	690 V / 50-60 Hz / 3 Ph
Heat power	4500 W	6000 W	7500 W	9000 W
Thermostat	20-90°C rated 25 A	20-90°C rated 25 A	20-90°C rated 25 A	20-90°C rated 25 A
Safety thermostat	120°C	120°C	120°C	120°C
Max. operating pressure	10 bar / 145 psi	10 bar / 145 psi	10 bar / 145 psi	10 bar / 145 psi
Surface load	3 W/cm ²	4 W/cm ²	5 W/cm ²	6 W/cm ²
Water inlet and outlet	2 x 1"	2 x 1"	2 x 1"	2 x 1"
Ingress protection	IP 67	IP 67	IP 67	IP 67
Pump power range	52 W / 230 V / 50-60 Hz	52 W / 230 V / 50-60 Hz	52 W / 230 V / 50-60 Hz	52 W / 230 V / 50-60 Hz
Pump flow rate	2.8 m ³ /h @ 3 m	2.8 m ³ /h @ 3 m	2.8 m ³ /h @ 3 m	2.8 m ³ /h @ 3 m
Weight	19.6 kg	19.6 kg	19.6 kg	19.6 kg
Dimensions (LxWxH)	464 x 190 x 291 mm	464 x 190 x 291 mm	464 x 190 x 291 mm	464 x 190 x 291 mm

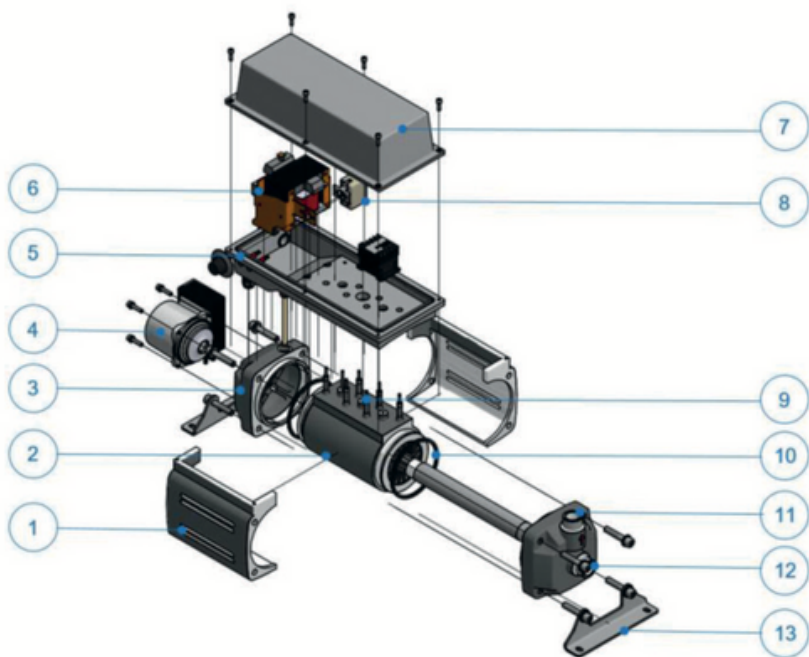

- 1 Side cover
- 2 Heat exchanger
- 3 Rear cover
- 4 Pump
- 5 Base plate
- 6 Transformer
- 7 Top cover
- 8 Thermostat
- 9 Heating element
- 10 Seal
- 11 Fluid OUT 1"
- 12 Fluid IN 1"
- 13 Support

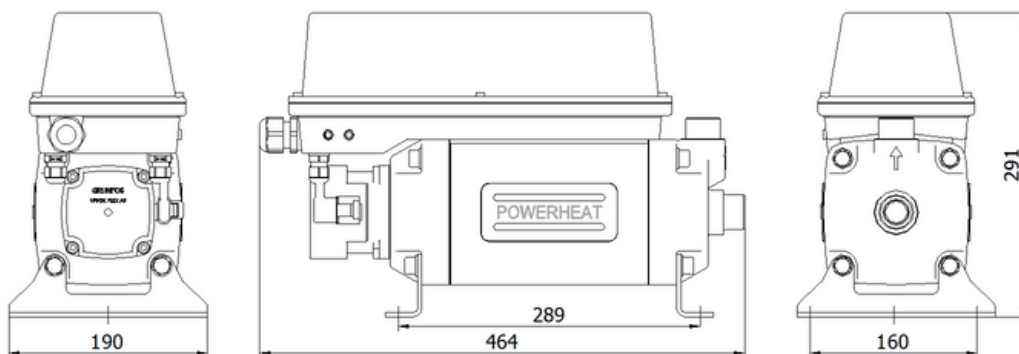

POWER SUPPLY
3 x 690V 50Hz

